

## QT-FIT8 3X36

QUICKTRONIC FIT 8 | ECG for FL 26 mm



### Product family features

- Supply voltage: 220...240 V
- Line voltage: 198...264 V
- Line frequency: 50 Hz | 60 Hz
- Lamp start with optimum filament preheating
- Energy Efficiency Index EEI: A2
- Automatic shutdown of defective lamps and at end of life (EoL T.2)
- Lamp operation: to EN 60929
- Safety: to EN 61347-2-3

### Product family benefits

- Long lamp life
- No adverse effect from frequent on/off switching
- Automatic restart after lamp replacement
- Perfect lamp start for applications with motion sensors
- VDE/VDE EMC certified system
- Very high energy efficiency due to cut-off technology

### Areas of application

- Open-plan offices, corridors and storage rooms
- Public buildings
- Strip lighting
- Suitable for luminaires of protection class I

# Product datasheet

## Technical data

### Electrical data

Input voltage AC	198...264 V
Nominal voltage	220...240 V
Mains frequency	50...60 Hz
Input voltage DC	185...264 V <sup>1)</sup>
Maximum output power	3 x 36 W
Efficiency in full-load	90 % <sup>2)</sup>
Operating frequency	40...50 kHz
Max. ECG no. on circuit breaker 10 A (B)	8 <sup>3)</sup>
Max. ECG no. on circuit breaker 16 A (B)	13 <sup>3)</sup>
Inrush current	15 A

<sup>1)</sup> Minimum voltage for lamp ignition: 198 V, 185...198 V for maximum 1 h

<sup>2)</sup> at 230 V, 50 Hz

<sup>3)</sup> Type B

### Light technical data

Starting time	2.0 s
---------------	-------

### Dimensions & weight

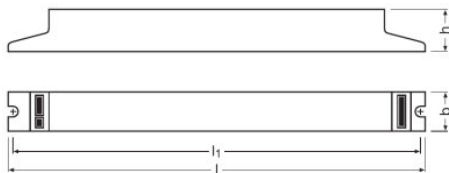

Length	280.0 mm
Width	40.0 mm
Height	28.0 mm
Mounting hole spacing, length	270.0 mm
Product weight	253.00 g
Cable cross-section, output side	0.5...1.5 mm <sup>2</sup> <sup>1)</sup>
Cable cross-section, input side	0.5...1.5 mm <sup>2</sup> <sup>1)</sup>

<sup>1)</sup> Solid leads

### Temperatures & operating conditions

Ambient temperature range	-15...+50 °C
Permitted rel. humidity during operation	5...85 % <sup>1)</sup>

<sup>1)</sup> Maximum 56 days/year at 85 %

### Lifespan

ECG lifetime	50000 h <sup>1)</sup>
--------------	-----------------------

<sup>1)</sup> At maximum T<sub>c</sub> / 10% failure rate

### Additional product data

Suitable for lamp power (3 lamps)	36 W
-----------------------------------	------

### Capabilities

Suitable for fixtures with prot. class	I
End of lamp life safety shutdown	EOL T.2
Max. cable length to lamp/LED module	1.0 m / 1.5 m
Dimmable	No
Intended for no-load operation	No

### Certificates & standards

Approval marks – approval	VDE / VDE-EMC / ENEC 10 / CE
EEI – Energy Label	A2
Standards	Acc. to EN 61347-2-3/Acc. to EN 60929/Acc. to EN 55015:2006 + A1:2007/Acc. to EN 61000-3-2/Acc. to EN 61547
Protection class	I
Type of protection	IP20

### Logistical data

Commodity code	85041080900
----------------	-------------

### Environmental information

Information according Art. 33 of EU Regulation (EC) 1907/2006 (REACH)	
Date of Declaration	09-06-2023
Primary Article Identifier	4008321512055
Candidate List Substance 1	Lead
CAS No. of substance 1	7439-92-1
Safe Use Instruction	The identification of the Candidate List substance is sufficient to allow safe use of the article.

## Product datasheet

Declaration No. in SCIP database	4456589b-ac29-40a6-8f7a-a2482d51556a
----------------------------------	--------------------------------------

### Wiring Diagram

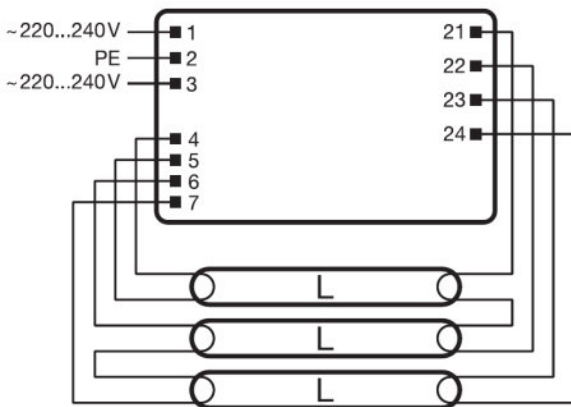





320045\_QT FIT8 3x36

### Additional product information





- In order to achieve good radio interference suppression:1. Keep the cable between ECG and lamp as short as possible.2. The single lamp wires must be routed as close as possible to each other, whereas the lines of the different lamp ends must be routed separately.

### Download Data

File	
	Certificates QT FIT8 CCC 2016171002000662 171221
	Certificates QT FIT8 CCC 2018171002002005 171221
	Certificates QT FIT8 CCC attachment, 02301-1002-170112-BG, 171221
	Certificates 334974_ENEC-Marks approval
	Certificates 335097_INOTEC

## Product datasheet

---

	Certificates 335150_CEAG
	Certificates 335169_Manufacturer's declaration &#150; LampECG combinations: Frequent switching
	Certificates 592319_EAC certificate for Quicktronics QT
	Certificates 504209_VDE-EMC-Certificate QT-Fit8
	Declarations of conformity QUICKTRONIC CE 3364256 060923

---

### Ecodesign regulation information:

Separate control gear and light sources must be disposed of at certified disposal companies in accordance with Directive 2012/19/EU (WEEE) in the EU and with Waste Electrical and Electronic Equipment (WEEE) Regulations 2013 in the UK. For this purpose, collection points for recycling centres and take-back systems (CRSO) are available from retailers or private disposal companies, which accept separate control gear and light sources free of charge. In this way, raw materials are conserved and materials are recycled.

---

### Logistical Data

Product code	Product description	Packaging unit (Pieces/Unit)	Dimensions (length x width x height)	Volume	Gross weight
4008321512055	QT-FIT8 3X36	Shipping carton box 20	303 mm x 210 mm x 132 mm	8.40 dm <sup>3</sup>	5333.00 g

---

The mentioned product code describes the smallest quantity unit which can be ordered. One shipping unit can contain one or more single products. When placing an order, for the quantity please enter single or multiples of a shipping unit.

---

### Disclaimer

Subject to change without notice. Errors and omission excepted. Always make sure to use the most recent release.

## QT-FIT8 3X36

QUICKTRONIC FIT 8 | ECG for FL 26 mm

Product name	Lamp group	Nominal current	Nominal wattage + Power loss	Power factor $\lambda$ [PIM]	Luminous flux at 35 °C	Number of lighting outlets
QT-FIT8 3X36	L 36 W	0.48 A	105.00 W	0.99	3500 lm	3