

## HTM 70/230...240

HALOTRONIC-COMPACT – HTM, HTN | Electronic transformers for low-voltage halogen lamps



### Product family features

- Line frequency: 50...60 Hz
- RI suppression: to EN 55015 (A1: 2007)/CISPR 15, EN 55022
- Line harmonics according to EN 61000-3-2
- Immunity according to EN 61547
- Safety: to EN 61347
- Short-circuit protection, overload protection, overtemperature protection: electronically reversible
- Electrical isolation between the primary side and the secondary side
- Dimmable on the leading edge (without HTN) and trailing edge

### Product family benefits

- Very low power loss thanks to high efficacy
- Strain relief suitable for different cable types (HTM)
- Suitable for space-critical installation thanks to compact functional design
- Extremely compact transformer for highly space-critical installation conditions (HTN)
- Protective operation throughout the entire partial-load range for long lamp life

### Areas of application

- Effect and accent lighting
- Living rooms
- Object lighting
- Conference rooms
- Restaurants
- Recessed and surface-mounted furniture luminaires
- Shop lighting
- Event rooms

## Technical data

### Electrical data

Lamp wattage	20...70 W
Maximum output power	70 W
Line current	0.27 A <sup>1)</sup>
Nominal voltage	230...240 V
Power factor $\lambda$	0.99
Operating frequency	52 kHz <sup>2)</sup>
Nominal output voltage	11.2 / 11.2 V <sup>3)</sup>
Input voltage AC	207...264 V
Mains frequency	50...60 Hz
System wattage	74.00 W
Efficiency in full-load	95 %
Input voltage range	230...240 V
Max. ECG no. on circuit breaker 10 A (B)	37
Max. ECG no. on circuit breaker 16 A (B)	59
Galvanic isolation primary/secondary	4.00 kV <sup>4)</sup>
Inrush current	0.3 A <sup>5)</sup>

<sup>1)</sup> Effectively

<sup>2)</sup> Approximately

<sup>3)</sup> 70 W / 20 W

<sup>4)</sup> eff

<sup>5)</sup> Maximum

### Dimensions & weight

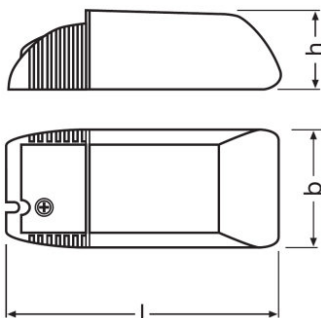

Length	108.0 mm
Width	52.0 mm
Mounting hole spacing, length	-
Height	33.0 mm

## Product datasheet

Mounting hole spacing, width	-
Cable cross-section, input side	2.5 mm <sup>2</sup>
Cable cross-section, output side	2.5 mm <sup>2</sup>
Wire preparation length, input side	12 / 7.0 mm <sup>1)</sup>
Wire preparation length, output side	12 / 7.0 mm <sup>1)</sup>
Product weight	110.00 g

<sup>1)</sup> Cable sheath / Wire

### Temperatures & operating conditions

Ambient temperature range	0...+50 °C
Maximum temperature at tc test point	80 °C

### Additional product data

Design / version	Compact with cable clamp
------------------	--------------------------

### Capabilities

Dimming method	Trailing- or leading-edge phase control for inductive load dimmers
Overload protection	Automatic reversible
Overheating protection	Automatic reversible
Short-circuit protection	Automatic reversible
Max. cable length to lamp/LED module	2.0 m
Cable/wire types, input side	NYM 3x1.5 / H05VV-F 3x0.75 / H05VV-F 3x1.0 / H05VV-F 3x1.5 / H05VV-F 2x0.75 / H05VV-F 2x1.5 / H05VVH2-F 2x0.75 / H05VVH2-F 2x1.5 mm <sup>2</sup>
Cable/wire types, output side	NYM 3x1.5 / H05VV-F 3x0.75 / H05VV-F 3x1.5 / H05VV-F 3x1.5 / H05VV-F 2x0.75 / H05VV-F 2x1.5 / H05VVH2-F 2x0.75 mm <sup>2</sup>
Dimmable	Yes
Dimming range	0...100 %
No-load proof	Yes
Suitable for fixtures with prot. class	II
Intended for no-load operation	No

### Certificates & standards

Approval marks – approval	VDE / VDE-EMC / E1 approval / EAC
Standards	Acc. to DIN VDE 0875/CISPR 15/EN 55015/Acc. to EN 61547/EN 61047/Acc. to IEC 61000-3-2/EN 61000-3-2/Acc. to EN 55015/Acc. to EN 61000-3-2/Acc. to EN 61547/Acc. to IEC 61347/Acc. to EN 61347/Acc. to EN 55015/Acc. to EN 61000-3-2/Acc. to EN 61547/Acc. to EN 61047

## Product datasheet

Type of protection	IP20
--------------------	------











### Logistical data

Commodity code	850440959000
----------------	--------------

### Environmental information

Information according Art. 33 of EU Regulation (EC) 1907/2006 (REACH)	
Date of Declaration	13-05-2022
Primary Article Identifier	4050300442310
Candidate List Substance 1	Lead
CAS No. of substance 1	7439-92-1
Safe Use Instruction	The identification of the Candidate List substance is sufficient to allow safe use of the article.
Declaration No. in SCIP database	8b145f50-5dc5-4dbb-90bd-b1e7a704b191

### Download Data

File	
	User instruction HALOTRONIC HTM HTN HTL
	User instruction HTLHTMHTN UI 080518
	Certificates 504178_EAC HT family
	Certificates VDE ENEC Certificate 40024665
	Certificates HALOTRONIC EMC 134590 280722
	Declarations of conformity HALOTRONIC ET PARROT CE 3674444 150222
	Installation/Operation notice 334738_HALOTRONIC &#150; Manual
	CAD data 3-dim 313437_108x52x33 9900021
	CAD data 3-dim 313457_108x52x33 9900021
	CAD data 3-dim 313479_108x52x33 9900021
	CAD data PDF 313411_108x52x33 9900021

## Product datasheet

---

### Ecodesign regulation information:

Separate control gear and light sources must be disposed of at certified disposal companies in accordance with Directive 2012/19/EU (WEEE) in the EU and with Waste Electrical and Electronic Equipment (WEEE) Regulations 2013 in the UK. For this purpose, collection points for recycling centres and take-back systems (CRSO) are available from retailers or private disposal companies, which accept separate control gear and light sources free of charge. In this way, raw materials are conserved and materials are recycled.

---

### Logistical Data

Product code	Product description	Packaging unit (Pieces/Unit)	Dimensions (length x width x height)	Volume	Gross weight
4050300442310	HTM 70/230...240	Shipping carton box 20	270 mm x 94 mm x 229 mm	5.81 dm <sup>3</sup>	2436.00 g

The mentioned product code describes the smallest quantity unit which can be ordered. One shipping unit can contain one or more single products. When placing an order, for the quantity please enter single or multiples of a shipping unit.

---

### Disclaimer

Subject to change without notice. Errors and omission excepted. Always make sure to use the most recent release.