

## QT-FIT5 3X14,4X14

QUICKTRONIC FIT 5 | ECG for FL 16 mm



### Product family features

- Supply voltage: 220...240 V
- Line voltage: 198...264 V
- Line frequency: 50 Hz | 60 Hz
- Lamp start with optimum filament preheating
- Energy Efficiency Index EEI: A2
- Automatic shutdown of defective lamps and at end of life (EoL T.2)
- Lamp operation: to EN 60929
- Safety: to EN 61347-2-3

### Product family benefits

- Long lamp life
- No adverse effect from frequent on/off switching
- Automatic restart after lamp replacement
- Perfect lamp start for applications with motion sensors
- VDE/VDE EMC certified system
- Very high energy efficiency due to cut-off technology

### Areas of application

- Open-plan offices, corridors and storage rooms
- Public buildings
- Strip lighting
- Suitable for luminaires of protection class I
- Modernization of existing systems

# Product datasheet

## Technical data

### Electrical data

Input voltage AC	198...264 V
Nominal voltage	220...240 V
Mains frequency	50...60 Hz
Input voltage DC	185...264 V <sup>1)</sup>
Maximum output power	4 x 14 W
Efficiency in full-load	89 % <sup>2)</sup>
Operating frequency	40...50 kHz
Max. ECG no. on circuit breaker 10 A (B)	12 <sup>3)</sup>
Max. ECG no. on circuit breaker 16 A (B)	19 <sup>3)</sup>
Inrush current	40 A

<sup>1)</sup> Minimum voltage for lamp ignition: 198 V, 185...198 V for maximum 1 h

<sup>2)</sup> at 230 V, 50 Hz

<sup>3)</sup> Type B

### Light technical data

Starting time	2.0 s
---------------	-------

### Dimensions & weight

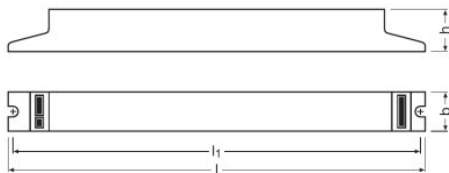

Length	280.0 mm
Width	40.0 mm
Height	21.0 mm
Mounting hole spacing, length	270.0 mm
Product weight	202.00 g
Cable cross-section, output side	0.5...1.5 mm <sup>2</sup> <sup>1)</sup>
Cable cross-section, input side	0.5...1.5 mm <sup>2</sup> <sup>1)</sup>

<sup>1)</sup> Solid leads

## Product datasheet

### Temperatures & operating conditions

Ambient temperature range	-15...+50 °C
Permitted rel. humidity during operation	5...85 % <sup>1)</sup>

<sup>1)</sup> Maximum 56 days/year at 85 %

### Lifespan

ECG lifetime	50000 h
--------------	---------

### Additional product data

Suitable for lamp power (3 lamps)	14 W
Suitable for lamp power (4 lamps)	14 W

### Capabilities

Suitable for fixtures with prot. class	I
End of lamp life safety shutdown	EOL T.2
Max. cable length to lamp/LED module	1.0 m / 1.5 m
Dimmable	No
Intended for no-load operation	No

### Certificates & standards

Approval marks – approval	VDE / ENEC 10 / VDE-EMC
EEL – Energy Label	A2 BAT
Standards	Acc. to EN 61347-2-3/IEC 61347-2-3/Acc. to EN 55015:2006 + A1:2007 + A2:2009/Acc. to EN 61000-3-2/IEC 61000-3-2/Acc. to EN 61547/IEC 61547
Protection class	I
Type of protection	IP20

### Logistical data

Commodity code	85041080900
----------------	-------------

### Environmental information

Information according Art. 33 of EU Regulation (EC) 1907/2006 (REACH)	
Date of Declaration	19-05-2023
Primary Article Identifier	4008321971210
Candidate List Substance 1	Lead
CAS No. of substance 1	7439-92-1
Safe Use Instruction	The identification of the Candidate List substance is sufficient to allow safe use of the article.

# Product datasheet

<b>Declaration No. in SCIP database</b>	7f3c0185-eeb5-41da-bb65-52e5d7c2cc4a
---	--------------------------------------

## Wiring Diagram

### QUICKTRONIC® FIT 5

QT-FIT5 3x14-20	QT-FIT5 3x14	QT-FIT5 3x14-20	QT-FIT5 3x14-20	QT-FIT5 3x14-20	QT-FIT5 3x14-20	QT-FIT5 3x14-20
120 V	120 V	120 V	120 V	120 V	120 V	120 V
100-147 mA	100-147 mA	100-147 mA	100-147 mA	100-147 mA	100-147 mA	100-147 mA
4.20 A	4.20 A	4.20 A	4.80 A	4.80 A	4.80 A	4.80 A
T <sub>th</sub>	220 µs	220 µs	220 µs	220 µs	220 µs	220 µs

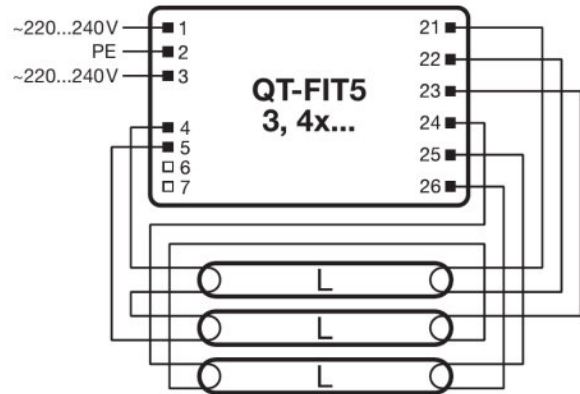
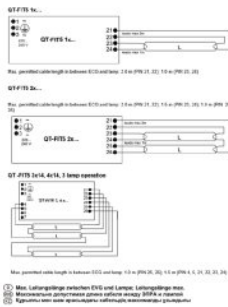

592456\_EAC QT-FIT5

723144\_Wiring diagram QT FIT5 3x..., 4x...

## Additional product information







- In order to achieve good radio interference suppression: 1. Keep the cable between ECG and lamp as short as possible. 2. The single lamp wires must be routed as close as possible to each other, whereas the lines of the different lamp ends must be routed separately.

## Download Data

File	
	User instruction QUICKTRONIC QT FIT5
	Product Datasheet 502688_ECG lifetime - QUICKTRONIC non DIM
	Product Datasheet 342812_QT-FIT5
	Certificates 339586_VDE-Marks approval
	Certificates 339588 EMC-Marks approval

## Product datasheet

---

	Certificates 592319_EAC certificate for Quicktronics QT
	Certificates 683441_ENEC-Marks approvals
	Declarations of conformity QUICKTRONIC CE 3364256 060923
	CAD data 3-dim 339654_CAD QT-FIT5 3-DIM.x_t
	CAD data 3-dim 339655_CAD QT-FIT5 3-DIM.STEP
	CAD data 3-dim 339656_CAD QT-FIT5 3-DIM.IGS
	CAD data PDF 339662_CAD QT-FIT5

---

### Ecodesign regulation information:

Separate control gear and light sources must be disposed of at certified disposal companies in accordance with Directive 2012/19/EU (WEEE) in the EU and with Waste Electrical and Electronic Equipment (WEEE) Regulations 2013 in the UK. For this purpose, collection points for recycling centres and take-back systems (CRSO) are available from retailers or private disposal companies, which accept separate control gear and light sources free of charge. In this way, raw materials are conserved and materials are recycled.

---

### Logistical Data

Product code	Product description	Packaging unit (Pieces/Unit)	Dimensions (length x width x height)	Volume	Gross weight
4008321971210	QT-FIT5 3X14,4X14	Shipping carton box 20	300 mm x 168 mm x 118 mm	5.95 dm <sup>3</sup>	4217.00 g

---

The mentioned product code describes the smallest quantity unit which can be ordered. One shipping unit can contain one or more single products. When placing an order, for the quantity please enter single or multiples of a shipping unit.

---

### Disclaimer

Subject to change without notice. Errors and omission excepted. Always make sure to use the most recent release.

## QT-FIT5 3X14,4X14

QUICKTRONIC FIT 5 | ECG for FL 16 mm

Product name	Lamp group	Nominal current	Nominal wattage + Power loss	Power factor $\lambda$ [PIM]	Luminous flux at 35 °C	Number of lighting outlets
QT-FIT5 3X14,4X14	HE 13 W ES	0.25 A	55.00 W	0.98	1150 lm	4
	HE 13 W ES	0.19 A	43.00 W	0.98	1150 lm	3
	HE 14 W	0.28 A	63.00 W	0.98	1200 lm	4