

DALI LS/PD CI

DALI LS/PD CI | Sensors for light management systems



Product family features

- Mounting height: 2...5 m
- Presence detection via passive IR element
- Light sensor operating range: 20...800 lx (measured at sensor)
- Daylight-dependent regulation and presence-dependent control of light
- Direct connection to DALI
- Function indicator with two-color LED
- Ceiling installation adapter

Product family benefits

- Can be addressed via DALI
- Daylight-dependent control with automatic shutdown in adequate daylight
- Multiple sensors can be networked
- Simple installation
- Sensor integration in DALI
- Power supply from DALI
- Presence detection angle adjustable between 40...90° via integrated shutters
- DALI based light management system integrable into building management systems

Areas of application

- Classrooms
- Conference rooms
- Corridors
- Individual offices
- Open-plan offices
- Restaurants
- Shop lighting
- Suitable for indoor applications

Product datasheet

Technical data

Dimensions & weight

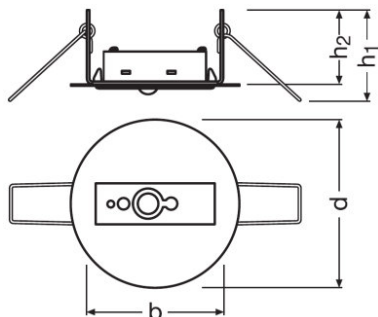

Length	80.0 mm
Product weight	95.00 g
Mounting hole spacing, diagonal	73 mm

Temperatures & operating conditions

Ambient temperature range	-20...+50 °C
---------------------------	--------------

Capabilities

Dimmable	No
Maximum installation height	5 m
Detection area	6 m ¹⁾
Detection angle	40...90 °
Operating range, light sensor	20...800 lx
Type of installation	Ceiling integration

¹⁾ Maximum diameter

Certificates & standards

Type of protection	IP20
--------------------	------

Logistical data

Commodity code	903180800000
----------------	--------------

Environmental information

Information according Art. 33 of EU Regulation (EC) 1907/2006 (REACH)	
Date of Declaration	13-02-2022







Product datasheet

Primary Article Identifier	4052899930292
Declaration No. in SCIP database	In work

Equipment / Accessories

– Suitable for many OSRAM DALI control systems

Download Data

File	
	User instruction DALI LSPD CI
	Declarations of conformity DALIECO SENSOR CE 2874588 160821
	Installation guide 538500_Mounting instructions DALI LSPD CI
	CAD data DALI LS PD CI IGS 220620
	CAD data DALI LS PD CI STEP 220620
	CAD Data 2-dim DALI LS PD CI CAD2PDF 220620
	CAD data 3-dim DALI LS PD CI CAD3PDF 220620

Logistical Data

Product code	Product description	Packaging unit (Pieces/Unit)	Dimensions (length x width x height)	Volume	Gross weight
4052899930292	DALI LS/PD CI	Shipping carton box 10	217 mm x 217 mm x 180 mm	8.48 dm ³	1230.00 g

The mentioned product code describes the smallest quantity unit which can be ordered. One shipping unit can contain one or more single products. When placing an order, for the quantity please enter single or multiples of a shipping unit.

Disclaimer

Subject to change without notice. Errors and omission excepted. Always make sure to use the most recent release.