

OT FIT 15/220...240/500 LT2 LP

OPTOTRONIC FIT LT2 LP | Compact Constant Current LED Drivers – Non dimmable



Areas of application

- Installation in emergency lighting systems according to IEC 61347-2-13, appendix J
- Luminaires with flexible current setting (LEDset2)
- Suitable for indoor SELV installations
- Suitable for luminaires of protection classes I and II
- Suitable for downlights, spotlights and LED panels
- Independent mounting via Cable Clamp Kit possible

Product family benefits

- Versatile scope of application due to output power range of up to 40 W
- Fulfill safety requirement due to overload, overtemperature protection
- High efficiency
- Higher quality of light thanks to < 5% output ripple current



Product datasheet

Product family features

- Supply voltage: 220...240 V
- Line frequency: 0 Hz | 50 Hz | 60 Hz
- Line voltage: 198...264 V
- According to EN 61347-1, 61347-2-13, 62384
- RI suppression: to EN 55015
- Line harmonics according to EN 61000-3-2
- Immunity according to EN 61547
- Lifetime: up to 100,000 h (temperature at $T_c = 65\text{ °C}$, max. 10 % failure rate)
- Independent connection via through-looping (depending on version of product)

Technical data

Electrical data

Nominal input voltage	220...240 V
Mains frequency	0/50/60 Hz
Input voltage AC	198...264 V
Input voltage DC	176...276 V
Total harmonic distortion	< 15 %
Power factor λ	0.95
ECG efficiency	84 %
Device power loss	3.0 W
Inrush current	14 A
Max. ECG no. on circuit breaker 10 A (B)	38
Max. ECG no. on circuit breaker 16 A (B)	60
Max. ECG no. on circuit breaker 25 A (B)	-
Surge capability (L/N-Ground)	2 kV ¹⁾
Surge capability (L-N)	1 kV
Nominal output voltage	15...50 V
U-OUT (working voltage)	60 V
Nominal output current	150...500 mA
Output current LEDset open	Not allowed
Output current LEDset shorted	500 mA
Output current tolerance	±5 %
Output ripple current (100 Hz)	< 5 %
Output PSTLM	≤1
Output SVM	≤0.4
Nominal output power	4.5...17.5 W
Galvanic isolation	SELV
Current set	LEDset2

¹⁾ L+N / PE of basic isolated LED module

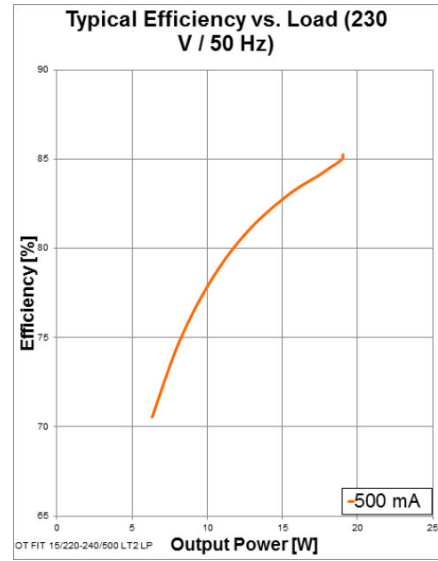
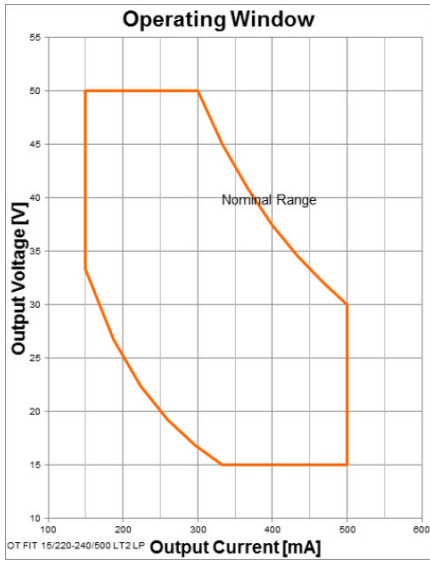

Operating Window

Typical Efficiency v Load 230 V 50 Hz

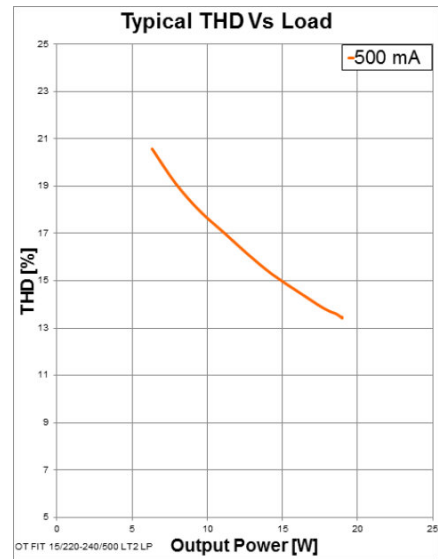
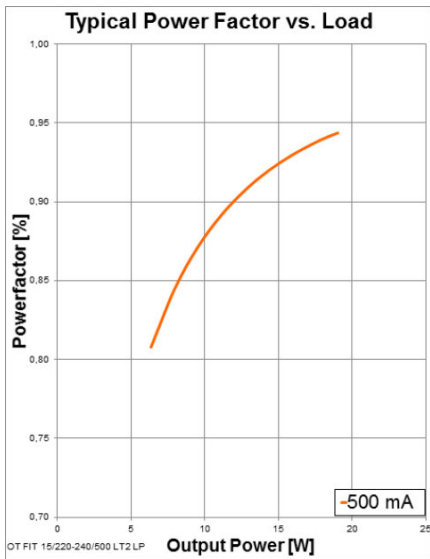

Typical Power Factor v Load

Typical THD v Load

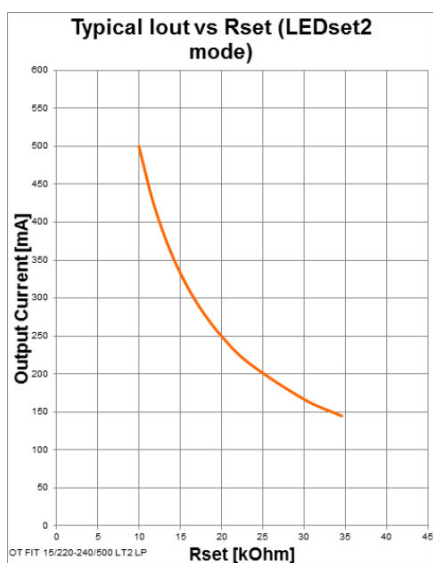

Typical Iout v Rset LEDset2 mode

Dimensions & weight

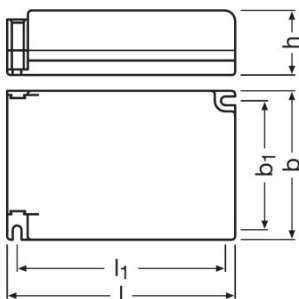

Mounting hole spacing, length	94.0 mm
Mounting hole spacing, width	58.0 mm
Product weight	110.00 g
Cable cross-section, input side	0.5...1.5 mm ²
Cable cross-section, output side	0.5...1.5 mm ²
Wire preparation length, input side	9.0...10.0 mm
Wire preparation length, output side	8.0...9.0 mm
Length	103.0 mm
Width	67.0 mm
Height	22.5 mm

Product datasheet

Colors & materials

Casing material	Plastic
-----------------	---------

Temperatures & operating conditions

Ambient temperature range	-20...+45 °C
Maximum temperature at tc test point	75 °C
Max.housing temperature in case of fault	110 °C
Temperature range at storage	-40...+85 °C
Permitted rel. humidity during operation	5...85 % ¹⁾

¹⁾ Maximum 56 days/year at 85 %

Lifespan

ECG lifetime	50000 / 100000 h ¹⁾
--------------	--------------------------------

¹⁾ $T_c = 75^\circ\text{C}$, 0.2% / 1,000 h failure rate / $T_c = 65^\circ\text{C}$, 0.1% / 1,000 h failure rate

Additional product data

Encapsulated	No
--------------	----

Capabilities

Dimmable	No
Overheating protection	Automatic reversible
Overload protection	Automatic reversible
Short-circuit protection	Automatic reversible
No-load proof	Yes
Max. cable length to lamp/LED module	2.0 m
Suitable for fixtures with prot. class	I / II
Type of connection, output side	Push terminal
Number of channels	1

Programming

Tuner4TRONIC	No
Tuner4TRONIC Field App	No
Programming device	LEDset

Certificates & standards

Approval marks – approval	CE
Standards	Acc. to IEC 61347-1/Acc. to IEC 61347-2-13/Acc. to IEC 62384/Acc. to IEC 61000-3-2/Acc. to IEC 61547/Acc. to EN 55015







Product datasheet

Type of protection	IP20
--------------------	------

Logistical data

Commodity code	850440829000
----------------	--------------

Download Data

File
 User instruction OPTOTRONIC LED Power Supply
 Product Datasheet Datasheet OT FIT 15LT2 LP
 Certificates OT ENEC 40038447 030720
 Certificates CEAG OT FIT 15220-240500 LT2 LP
 Certificates INOTEC OT FIT 15220-240500 LT2 LP
 Certificates CCC Certificate 2018171002002031
 Certificates CCC Certificate 2018171002002041
 Declarations of conformity EU Declaration of Conformity 3520188
 CAD data 3-dim OT FIT-LT2-15-25-40 cable clamp 3Ddrawing
 CAD data 3-dim OT FIT-LT2-15-25-40 housing 3Ddrawing
 CAD data 3-dim OT FIT-LT2-15-25-40 housing with cable clamp 3Ddrawing

Logistical Data

Product code	Product description	Packaging unit (Pieces/Unit)	Dimensions (length x width x height)	Volume	Gross weight
4052899490673	OT FIT 15/220...240/500 LT2 LP	Shipping carton box 20	348 mm x 218 mm x 67 mm	5.08 dm ³	2362.00 g

The mentioned product code describes the smallest quantity unit which can be ordered. One shipping unit can contain one or more single products. When placing an order, for the quantity please enter single or multiples of a shipping unit.

Product datasheet

Disclaimer

Subject to change without notice. Errors and omission excepted. Always make sure to use the most recent release.