

PL-CORE-G7 3000-927 L15 H1

PrevaLED Core G7 Food | Spot-, Down- and Wallmount Light Engines and Modules



Product family features

- Complete portfolio with varying luminous flux, color temperature, color rendering
- Lifetime (L80/B10): 60,000 h (temperature at $T_p = 65\text{ °C}$)
- LED module is basic isolated to mounting surface
- Photobiological safety according to IEC/TR 62778, risk group RG1
- Max. working voltage: 60 V (to be operated only on SELV LED control gear)

Product family benefits

- Easy integration thanks to very compact form factor
- Easy cooling due to optimized efficiency and high maximum operation temperature
- High driver flexibility allows cost-effective and intelligent systems
- 5 year guarantee

Areas of application

- Excellent light for FOOD applications
- Spotlighting in shops and retail
- Down- and wall lighting in offices, corridors, meeting rooms, workplaces
- Decorative and functional lighting in hospitality, hotels, restaurants
- Functional lighting in public and commercial buildings



Product datasheet

Technical data

Electrical data

Nominal voltage	36.1 V
Type of current	DC
Nominal current	0.749 A
On-mode power	27.1 W
Energy consumption in on-mode	27.1 kWh/1000h

Photometrical data

Luminous efficacy	111 lm/W
Color rendering index Ra	≥90
Light color (designation)	Neutral White
Correlated color temperature CCT	2700 K
Peak luminous intensity	1065
Colour consistency (McAdam ellipses)	3
Useful luminous flux (Φ_{use})	2349 lm ¹⁾

¹⁾ 120°

Light technical data

Starting time	0.0 s
Warm-up time (60 %)	0.00 s

Dimensions & weight

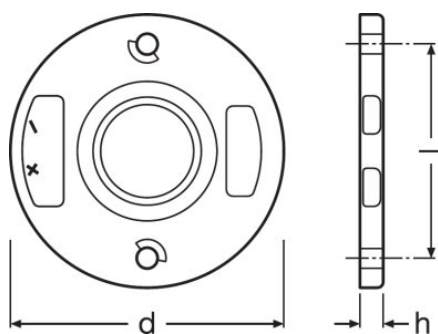

Product weight	6.00 g
Height	3 mm
Length	44 mm
Width	44 mm
Diameter	44.0 mm

Temperatures & operating conditions

Performance temp. acc. to IEC 62717	65 °C
Maximum temperature at tc test point	100 °C
Ambient temperature range	-20...+50 °C
Temperature range at storage	-20...60 °C

Lifespan

Number of switching cycles	100000
Lumen maintenance factor LMF	96
L70B50 lifetime	60000 h

Additional product data

Product remark	Modules perfectly matched to OSRAM OPTOTRONIC LED drivers (see relevant table)/For current photometric data and important safety, installation and application information (see www.osram.com/led-systems)/All the technical parameters apply to the entire module. In view of the complex manufacturing process for light emitting diodes, the typical values given above for the technical LED parameters are merely statistical values that do not necessarily correspond to the actual technical parameters of an individual product; individual products may vary from the typical values/Tolerance for optical and electrical data: +/-10%/OSRAM is not liable for errors in luminaires design and assembly
Lighting technology used	LED

Certificates & standards

Standards	CE/ENEC
Type of protection	IP20
Energy efficiency class	F

Logistical data

Commodity code	854141000000
----------------	--------------







Environmental information

Information according Art. 33 of EU Regulation (EC) 1907/2006 (REACH)	
Date of Declaration	18-04-2022
Primary Article Identifier	4052899534544
Candidate List Substance 1	No declarable substances contained
Declaration No. in SCIP database	No declarable substances contained



664174_5 Year OSRAM
Guarantee (LED)

Download Data

File	
	Addon Technical Information PrevaLED Core G7 Overview
	Certificates ENEC Certificate PL CORE G7
	Declarations of conformity PL CORE G7 CE 3610978 150322
	CAD data PL CORE G7 L15 H1 IGS 150520
	CAD data PL CORE G7 L15 H1 STEP 150520
	CAD Data 2-dim PL CORE G7 L15 H1 CAD2PDF 150520
	CAD data 3-dim PL CORE G7 L15 H1 CAD3PDF 150520

Ecodesign regulation information:

Separate control gear and light sources must be disposed of at certified disposal companies in accordance with Directive 2012/19/EU (WEEE) in the EU and with Waste Electrical and Electronic Equipment (WEEE) Regulations 2013 in the UK. For this purpose, collection points for recycling centres and take-back systems (CRSO) are available from retailers or private disposal companies, which accept separate control gear and light sources free of charge. In this way, raw materials are conserved and materials are recycled.

Product datasheet

Logistical Data

Product code	Product description	Packaging unit (Pieces/Unit)	Dimensions (length x width x height)	Volume	Gross weight
4052899534544	PL-CORE-G7 3000-927 L15 H1	Shipping carton box 40	375 mm x 263 mm x 38 mm	3.75 dm ³	807.00 g

The mentioned product code describes the smallest quantity unit which can be ordered. One shipping unit can contain one or more single products. When placing an order, for the quantity please enter single or multiples of a shipping unit.

References / Links

For Guarantee see

▶ www.osram.com/guarantee

Disclaimer

Subject to change without notice. Errors and omission excepted. Always make sure to use the most recent release.
