

PL-CN50-COB- 1400-935-40D-G2

PrevaLED COIN 50 COB G2 | LED modules with integrated optics and heat sink



Product family features

- Color consistency < 2 SDCM
- TM30 compliant
- High flux output up to 1500 lm
- Beam angle: 15°, 24°, 40°
- Type of protection: IP20

Product family benefits

- Compatible with conventional MR16 lamps
- Precise optical control and free from multi-shadow issue
- Replaceable front cover to maximize optics flexibility and future extension
- Dual mode options in High-Output (HO) and High-Efficacy (HE)

Areas of application

- Retail, shop, restaurant, hospitality
- High-end residential
- Suitable for indoor applications
- Connecting multiple modules in parallel on one LED driver is not permitted
- Connecting multiple modules in series on one LED driver is not recommended
- Do not use in sealed fixtures
- Avoid covering the lens with dust or any object



Product datasheet

Technical data

Electrical data

Nominal current	0.35 A
Nominal voltage	36.5 V
Type of current	DC
On-mode power	12.50 W
Energy consumption in on-mode	12.5 kWh/1000h ¹⁾

1) _

Photometrical data

Luminous efficacy	102 lm/W
Light color (designation)	3500 K
Color rendering index Ra	90
Correlated color temperature CCT	3400 K
Peak luminous intensity	2450
Colour consistency (McAdam ellipses)	2
Useful luminous flux (Φ_{use})	1100 lm ¹⁾

1) 90°

Light technical data

Starting time	< 0.5 s
Warm-up time (60 %)	< 2.00 s
Beam angle	40 °

Dimensions & weight

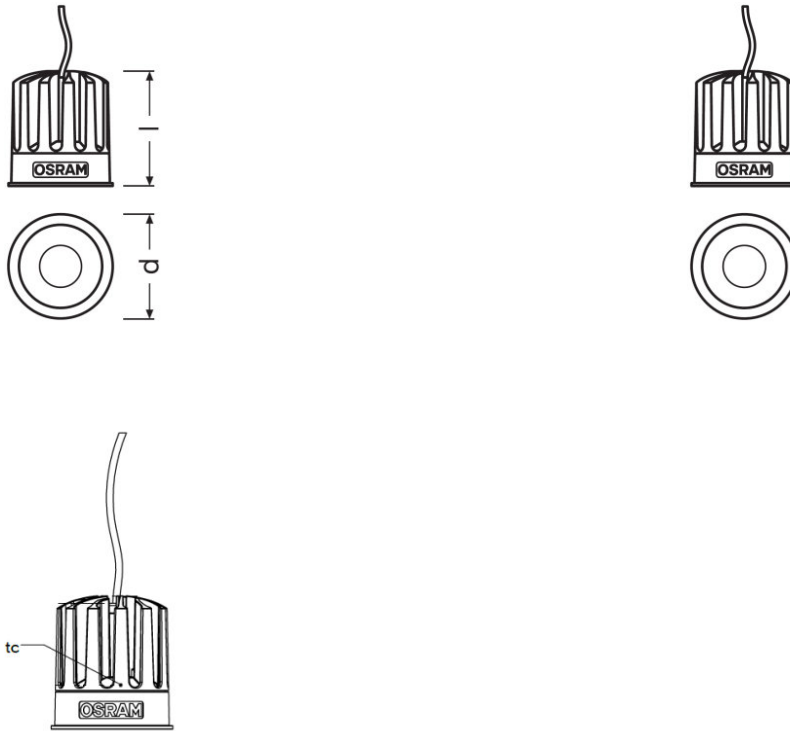

Diameter	50.0 mm ¹⁾
Product weight	90.00 g
Height	55.0 mm
Length	50.0 mm
Width	50.0 mm

¹⁾ ±0.3 mm

Colors & materials

Heatsink color	Grey
----------------	------

Temperatures & operating conditions

Performance temp. acc. to IEC 62717	70 °C
Maximum temperature at tc test point	90 °C
Ambient temperature range	-25...+40 °C
Temperature range at storage	-40...80 °C

Lifespan

Number of switching cycles	15000
----------------------------	-------

Product datasheet

Lumen maintenance factor LMF	96 ¹⁾
L70B50 lifetime	50000 h ¹⁾

1) _

Additional product data

Product remark	Modules perfectly matched to OSRAM OPTOTRONIC LED drivers (see relevant table)/For current photometric data and important safety, installation and application information (see www.osram.com/led-systems),/All the technical parameters apply to the entire module. In view of the complex manufacturing process for light emitting diodes, the typical values given above for the technical LED parameters are merely statistical values that do not necessarily correspond to the actual technical parameters of an individual product; individual products may vary from the typical values/Tolerance for optical and electrical data: +/-10%
Lighting technology used	LED

Capabilities

Dimmable	Yes
----------	-----

Certificates & standards

Standards	Acc. to IEC 62471/Acc. to EN 60598-1/Acc. to EN 60529/Acc. to EN 55015/Acc. to EN 61547/Acc. To EN62031 IEC 605981/CE
Type of protection	IP20
Energy efficiency class	F

Logistical data

Commodity code	85395100000
----------------	-------------





Environmental information

Information according Art. 33 of EU Regulation (EC) 1907/2006 (REACH)	
Date of Declaration	20-07-2022
Primary Article Identifier	4052899621312
Candidate List Substance 1	No declarable substances contained
Declaration No. in SCIP database	No declarable substances contained

Download Data

File

Product datasheet

	Certificates PL CN50 COB 1400 G2 ENEC 181121
	CAD data PL CN50 COB G2 STEP 160321
	CAD data PL CN50 G2 STEP 041121
	IES data PL CN50 COB 1400 935 40D G2.1 IES 120522

Logistical Data

Product code	Product description	Packaging unit (Pieces/Unit)	Dimensions (length x width x height)	Volume	Gross weight
4052899621312	PL-CN50-COB- 1400-935-40D-G2	Shipping carton box 20	268 mm x 110 mm x 138 mm	4.07 dm ³	2156.00 g

The mentioned product code describes the smallest quantity unit which can be ordered. One shipping unit can contain one or more single products. When placing an order, for the quantity please enter single or multiples of a shipping unit.

Accessories Optional

Product description	Accessory name	Accessory code
PL-CN50-COB- 1400-935-40D-G2	PL-CN50 -ROUND-RING	▶ 4062172134842
PL-CN50-COB- 1400-935-40D-G2	24D LENS FOR COIN 50 COB G2	▶ 4062172235037
PL-CN50-COB- 1400-935-40D-G2	BLACK COVER FOR COIN 50 COB G2	▶ 4062172251808

Disclaimer

Subject to change without notice. Errors and omission excepted. Always make sure to use the most recent release.