

GFDS600-G1 830-05

GINOLED Flex DIFFUSE Side - Monowhite | Linear LED modules for flexible and individualized lighting solutions



Product family features

- 3 SDCM, CRI80
- Large selection of lighting color temperatures
- 110° viewing angle per module
- Up to 50,000 h lifetime @ tc max
- Dimmable with PWM technology

Product family benefits

- Cut to length each 41.7 mm
- 10x10 mm super slim design, fit for embedded applications
- Diffuse version, side emitting, high light uniformity without spot or dark area
- IP67 protection for truly outdoor application

Areas of application

- Outdoor and indoor contour lighting
- Signage
- Cove lighting
- Decorative lighting
- Architectural lighting
- Accent lighting



Technical data

Electrical data

Nominal voltage	24.0 V
Type of current	DC
Rated wattage	45.00 W
Input voltage range	23...25 V
Accidental reverse input voltage protection up to	26 V
Nominal wattage per meter	9.0 W

Photometrical data

Light color LED	White
Color rendering index Ra	80
Luminous efficacy	68.89 lm/W
Light color (designation)	3000 K
Color temperature	3000 K
Standard deviation of color matching	≤3 sdc _m
Luminous flux per meter	620 lm
Correlated color temperature CCT	-
Peak luminous intensity	-
Total useful luminous flux	3100 lm

Light technical data

Beam angle	110 °
Starting time	0.0 s
LED pitch	6.95 mm
Warm-up time (60 %)	0.00 s

LED module information

Number of LEDs per smallest unit	6
Number of LEDs per meter	144

Dimensions & weight

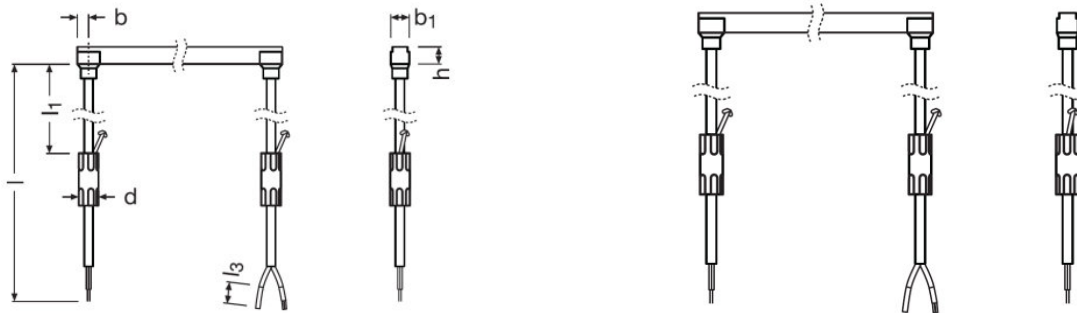

Length	5000 mm
Product weight	650.00 g
Cable cross-section, input side	0.3247 mm ²
Length – smallest unit	41.7 mm
Width	11.0 mm
Height	10.5 mm
Cable length	300.0

Colors & materials

Body material	Silicone
Cover material	Silicone

Temperatures & operating conditions

Temperature range in operation at Tc point	Max 65°C@6W/m; Max 75°C@11W/m °C ¹⁾
Ambient temperature range	-40...+55 °C
Temperature range at storage	-40...60 °C
Performance temp. acc. to IEC 62717	RG0

¹⁾ Exceeding the maximum ratings will reduce expected life time or destroy the LED strip.

Lifespan

Number of switching cycles	15000
Rated lamp life time	50000 h
Lumen main.fact.at end of nom.life time	0.70
Nominal lamp life time	50000 h

Additional product data

ID of contained light source	LS_SHZ_600981 ¹⁾
------------------------------	-----------------------------

Product datasheet

1) _

Capabilities

Dimmable	Yes
Lowest bending radius	100 mm
With end piece	No
With connection set	Yes
Control interface	-
Detection angle (Light sensor)	-
Detection angle (PIR)	-
Colour-tuneable light source	-

Certificates & standards

Standards	Acc. to EN 61347-2-13/Acc. to EN 55015/Acc. to EN 61547/Acc. to EN 61000-3-2
Type of protection	IP67
Energy efficiency class of the contained light source	F ¹⁾
Energy consumption	50 kWh/1000h

1) _



Logistical data

Commodity code	940542319000
----------------	--------------

Environmental information

Information according Art. 33 of EU Regulation (EC) 1907/2006 (REACH)	
Date of Declaration	18-04-2022
Primary Article Identifier	4062172194983
Candidate List Substance 1	No declarable substances contained
Declaration No. in SCIP database	No declarable substances contained

Download Data

File	
	User instruction GinoLED Diffuse White Flex
	Declarations of conformity GFD SW+TW CE 4283939 040221
	Declarations of conformity GINOLED FD TW UK CE 4237513 040221

Product datasheet

Ecodesign regulation information:

- This product is considered to be a "containing product" in the sense of Regulations (EU) 2019/2020 and (EU) 2019/2015.
- Tolerances of the reported values, are according to LED Modules Performance standard IEC/EN 62717.
- In general, the replacement of the contained light sources without permanent damage to the product with the use of common available tools is possible in the final application when they can be dismantled from the installation environment and substituted for the necessary number of light sources restoring its full electrical/mechanical/thermal/optical functionality by means of a professional installer. In the contrary, and limited to the LINEARlight Flex Diffuse, LINEARlight Rigid Finesse, GINO LED Flex Diffuse and LUMINENT Milky product families, the contained light source is an integrated part of the containing product and its removal can only be done by causing a permanent damage to the containing product due to its tight mechanical, electrical, optical, thermal interaction and/or environmental protection with or from the containing product. Therefore, a replacement of the light source with the use of common available tools is not justified.
- Dismantling of light sources from containing products at end of life: Containing products with light sources which are scalable in length can be cut to the length of the contained light source and if applicable mechanically detached from protective and/or optical covers. Containing products shall be separated from building material and/or from other additional mounting accessories by means of a professional installer. Separate control gear and light sources must be disposed of at certified disposal companies in accordance with Directive 2012/19/EU (WEEE) in the EU and with Waste Electrical and Electronic Equipment (WEEE) Regulations 2013 in the UK. For this purpose, collection points for recycling centres and take-back systems (CRSO) are available from retailers or private disposal companies, which accept separate control gear and light sources free of charge. In this way, raw materials are conserved and materials are recycled.

Logistical Data

Product code	Product description	Packaging unit (Pieces/Unit)	Dimensions (length x width x height)	Volume	Gross weight
4062172194983	GFDS600-G1 830-05	Shipping carton box 3	475 mm x 360 mm x 145 mm	24.80 dm ³	4530.00 g

The mentioned product code describes the smallest quantity unit which can be ordered. One shipping unit can contain one or more single products. When placing an order, for the quantity please enter single or multiples of a shipping unit.

Disclaimer

Subject to change without notice. Errors and omission excepted. Always make sure to use the most recent release.