

## LINEARlight Flex DIFFUSE IP67 connector

Accessories for Flexible LED strips

### Product family features

- Quick and easy installation
- Compatible with Linearlight Flex
- Compatible with TEC Flex



### Product family benefits

- Simple installation, no tools or soldering required (CONNECTsystem)
- Reduced installation time (CONNECTsystem)
- Can be connected to the front of the module or at division points (CONNECTsystem)
- Low profile (CONNECTsystem)

## Product family datasheet

### Technical data

Product description	Dimensions & weight				Logistical data
	Height	Width	Length	Product weight	Commodity code
FX-DCS -G1-CM2PF-IP67-500-X5	19.0 mm	18.5 mm	26.6 mm	105.00 g	853669909900
FX-DCS -G1-CM2PF-IP67-TOPKIT5	30.0 mm	150.0 mm	260.0 mm	122.30 g	853669909900
FX-DCS -G1-CM2PF-IP67-SIDEKIT5	30.0 mm	150.0 mm	260.0 mm	118.10 g	853669909900
FX-DCS -G1-CM2PJ-IP67-0190-X5	19.0 mm	18.5 mm	26.6 mm	85.00 g	853669909900
FX-DCS -G1-CM2PJ-IP67-TOPKIT5	30.0 mm	150.0 mm	260.0 mm	102.30 g	853669909900
FX-DCS -G1-CM2PJ-IP67-SIDEKIT5	30.0 mm	150.0 mm	260.0 mm	98.10 g	853669909900
FX-DCS -G1-ECT-KIT20	11.6 mm	16.1 mm	9.2 mm	34.60 g	392690979000
FX-DCS -G1-ECS-KIT20	14.1 mm	12.0 mm	6.2 mm	26.20 g	392690979000
FX-DCS -G1-EHT-KIT20	11.6 mm	16.1 mm	17.0 mm	63.00 g	392690979000
FX-DCS -G1-EHS-KIT20	14.5 mm	12.4 mm	11.0 mm	51.40 g	392690979000
FX-DCS -G1-GL-25	30.0 mm	150.0 mm	100.0 mm	26.00 g	350610000000

Product description	Environmental information Information according Art. 33 of EU Regulation (EC) 1907/2006 (REACH)			
	Date of Declaration	Primary Article Identifier	Candidate List Substance 1	Declaration No. in SCIP database
FX-DCS -G1-CM2PF-IP67-500-X5	19-02-2022	4052899451971	No declarable substances contained	No declarable substances contained
FX-DCS -G1-CM2PF-IP67-TOPKIT5	12-02-2022	4052899451995	No declarable substances contained	No declarable substances contained
FX-DCS -G1-CM2PF-IP67-SIDEKIT5	12-02-2022	4052899452015	No declarable substances contained	No declarable substances contained
FX-DCS -G1-CM2PJ-IP67-0190-X5	12-02-2022	4052899452039	No declarable substances contained	No declarable substances contained
FX-DCS -G1-CM2PJ-IP67-TOPKIT5	12-02-2022	4052899452053		In work
FX-DCS -G1-CM2PJ-IP67-SIDEKIT5	12-02-2022	4052899452077	No declarable substances contained	No declarable substances contained
FX-DCS -G1-ECT-KIT20	12-02-2022	4052899452107	No declarable substances contained	No declarable substances contained
FX-DCS -G1-ECS-KIT20	12-02-2022	4052899452121	No declarable substances contained	No declarable substances contained
FX-DCS -G1-EHT-KIT20	19-01-2022	4052899452176		In work
FX-DCS -G1-EHS-KIT20	12-02-2022	4052899452206	No declarable substances contained	No declarable substances contained
FX-DCS -G1-GL-25	12-02-2022	4052899452244	No declarable substances contained	No declarable substances contained

## Product family datasheet

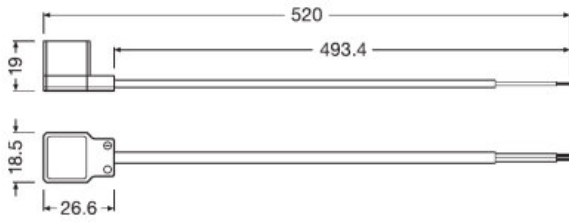

728401\_Middle power feeder Flex Diffuse

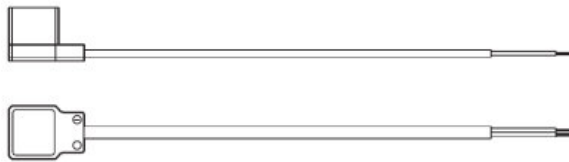

728433\_Middle power feeder Flex Diffuse

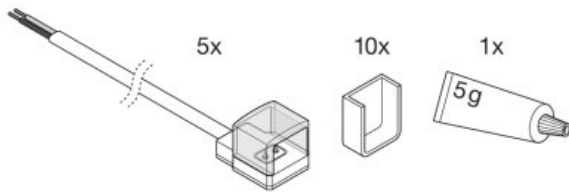

728707\_LINEARlight FLEX DIFFUSE FX-DCS-G1-CM2PF-IP67-SIDEKIT5

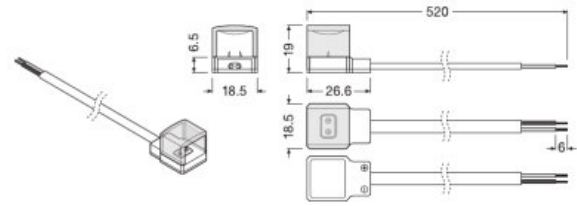

728697\_LINEARlight FLEX DIFFUSE FX-DCS-G1-CM2PF-IP67-0500-X5

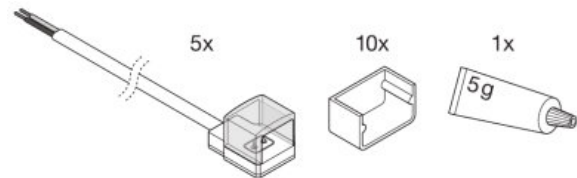

728701\_LINEARlight FLEX DIFFUSE FX-DCS-G1-CM2PF-IP67-TOPKIT5

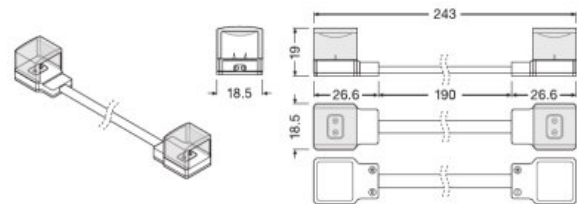

728698\_LINEARlight FLEX DIFFUSE FX-DCS-G1-CM2PJ-IP67-0190-X5

## Product family datasheet

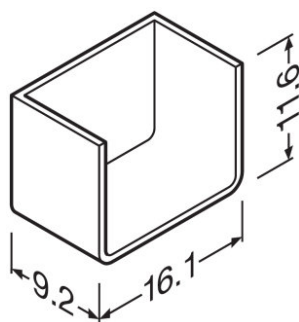

728402\_Single sided endcaps for top-bending modules

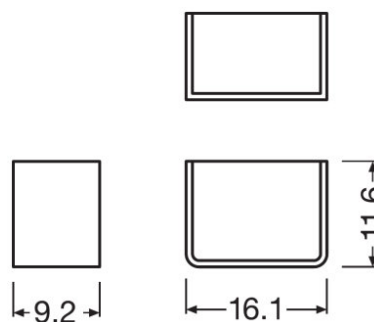

728403\_Single sided endcaps for top-bending modules

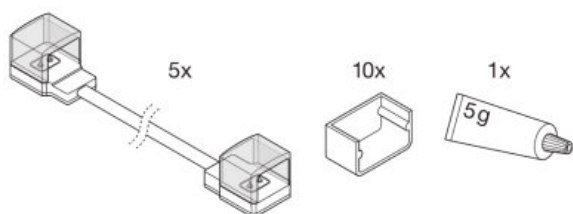

728702\_LINEARlight FLEX DIFFUSE FX-DCS-G1-CM2PJ-IP67-TOPKIT5

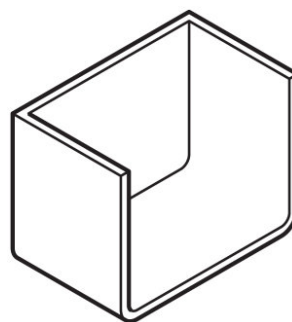

728434\_Single sided endcaps for top-bending modules

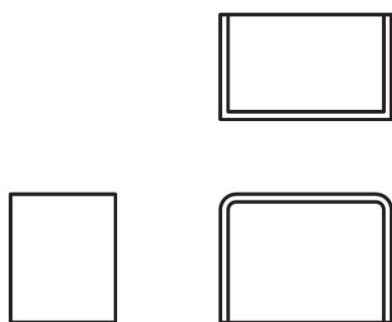

728435\_Single sided endcaps for top-bending modules

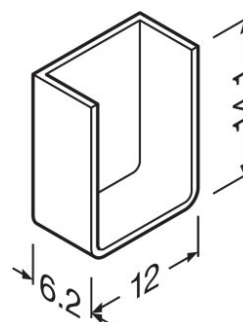

728404\_Single sided endcaps for side-bending modules

Product family datasheet

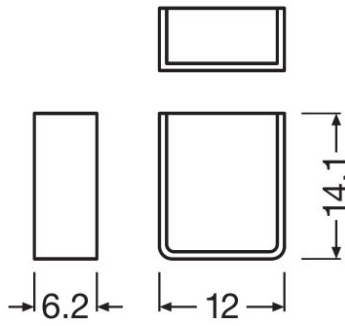

728405\_Single sided endcaps for side-bending modules

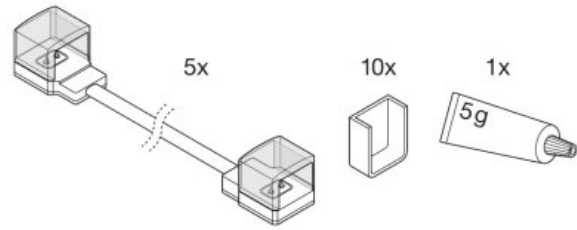

728708\_LINEARlight FLEX DIFFUSE FX-DCS-G1-CM2PJ-IP67-SIDEKIT5

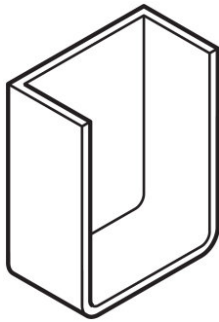

728436\_Single sided endcaps for side-bending modules

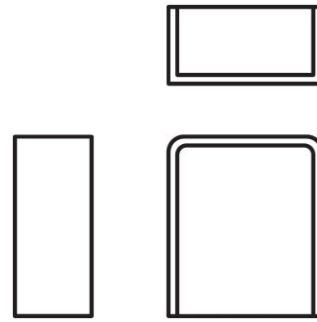

728437\_Single sided endcaps for side-bending modules

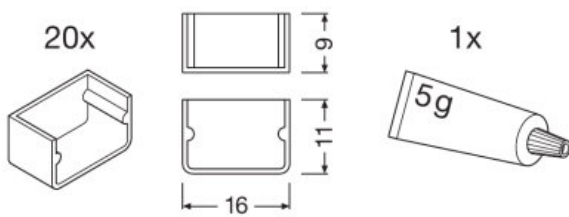

728687\_DS063\_PG\_LINEARlight\_FLEX\_DIFFUSE\_FX-DCS-G1-ECT-KIT20

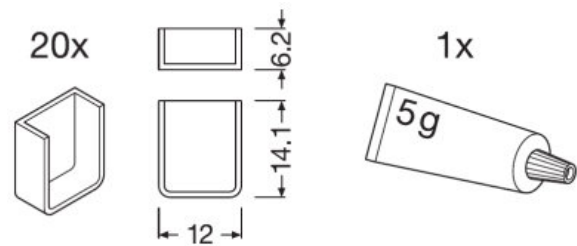

728705\_LINEARlight FLEX DIFFUSE FX-DCS-G1-ECS-KIT20

## Product family datasheet

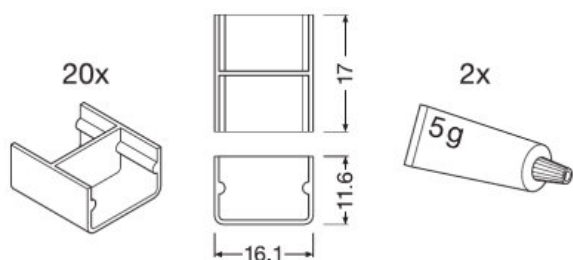

728700\_LINEARlight FLEX DIFFUSE FX-DCS-G1-EHT-KIT20

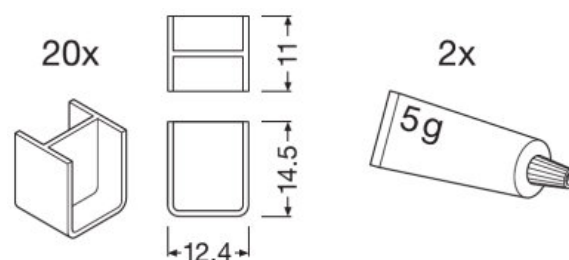

728706\_LINEARlight FLEX DIFFUSE FX-DCS-G1-EHS-KIT20

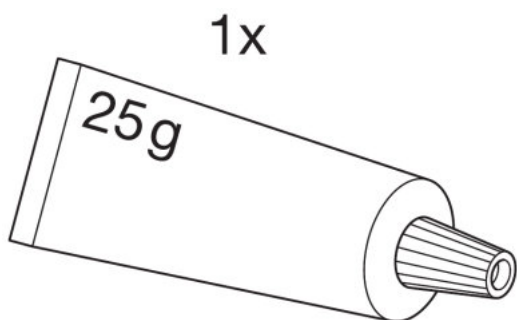

728711\_LINEARlight FLEX DIFFUSE FX-DCS-G1-GL-25

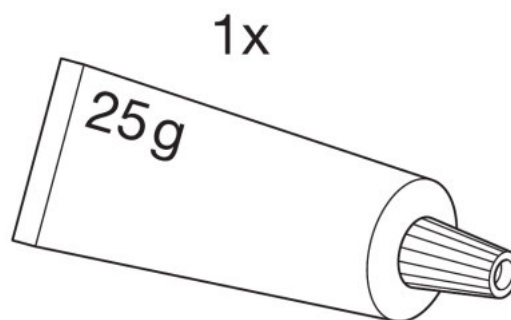

729229\_LINEARlight FLEX DIFFUSE FX-DCS-G1-GL-25

### Application advice

For more detailed application information and graphics please see product datasheet.

### Sales and Technical Support

Sales and Technical Support [www.osram.com](http://www.osram.com)

### Download Data

#### File



User instruction  
LINEARLIGHT Flex Diffuse Installation Guide - Naed Version (EN)

## Product family datasheet



Brochures  
Light is freedom of design (EN)

### Logistical Data

Product code	Product description	Packaging unit (Pieces/Unit)	Dimensions (length x width x height)	Volume	Gross weight
4052899451971	FX-DCS -G1-CM2PF-IP67-500-X5	Shipping carton box 10	195 mm x 295 mm x 160 mm	9.20 dm <sup>3</sup>	1295.00 g
4052899451995	FX-DCS -G1-CM2PF-IP67-TOPKIT5	Shipping carton box 10	195 mm x 295 mm x 160 mm	9.20 dm <sup>3</sup>	1468.00 g
4052899452015	FX-DCS -G1-CM2PF-IP67-SIDEKIT5	Shipping carton box 10	195 mm x 295 mm x 160 mm	9.20 dm <sup>3</sup>	1426.00 g
4052899452039	FX-DCS -G1-CM2PJ-IP67-0190-X5	Shipping carton box 10	195 mm x 295 mm x 160 mm	9.20 dm <sup>3</sup>	1095.00 g
4052899452053	FX-DCS -G1-CM2PJ-IP67-TOPKIT5	Shipping carton box 10	195 mm x 295 mm x 160 mm	9.20 dm <sup>3</sup>	1268.00 g
4052899452077	FX-DCS -G1-CM2PJ-IP67-SIDEKIT5	Shipping carton box 10	195 mm x 295 mm x 160 mm	9.20 dm <sup>3</sup>	1226.00 g
4052899452107	FX-DCS -G1-ECT-KIT20	Shipping carton box 10	200 mm x 200 mm x 110 mm	4.40 dm <sup>3</sup>	496.00 g
4052899452121	FX-DCS -G1-ECS-KIT20	Shipping carton box 10	200 mm x 200 mm x 110 mm	4.40 dm <sup>3</sup>	412.00 g
4052899452176	FX-DCS -G1-EHT-KIT20	Shipping carton box 10	200 mm x 200 mm x 110 mm	4.40 dm <sup>3</sup>	780.00 g
4052899452206	FX-DCS -G1-EHS-KIT20	Shipping carton box 10	200 mm x 200 mm x 110 mm	4.40 dm <sup>3</sup>	664.00 g
4052899452244	FX-DCS -G1-GL-25	Shipping carton box 20	200 mm x 200 mm x 110 mm	4.40 dm <sup>3</sup>	760.00 g

The mentioned product code describes the smallest quantity unit which can be ordered. One shipping unit can contain one or more single products. When placing an order, for the quantity please enter single or multiples of a shipping unit.

### Disclaimer

Subject to change without notice. Errors and omission excepted. Always make sure to use the most recent release.