

FX-QMS-G1 -TU15H6-300

FX-QMS-G1-TU15H6 | Accessories for Flexible LED strips



Product family features

- Can be easily combined with covers for homogeneous light distribution
- Clips for easy installation and maintenance
- Compatible with LINEARlight Flex and TEC Flex
- Ideal even for lighting in confined spaces
- Compatible with LF Protect and TF Protect without cover

Product family benefits

- Plenty of freedom for attractive design and perfect functioning
- Quick and easy installation
- Aluminum profile robust and corrosion-resistant thanks to anodization
- Minimum installation dimensions thanks to compact design

Product datasheet

Technical data

Dimensions & weight

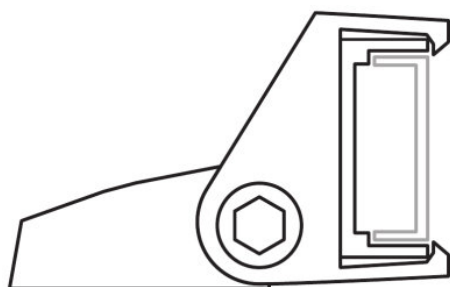
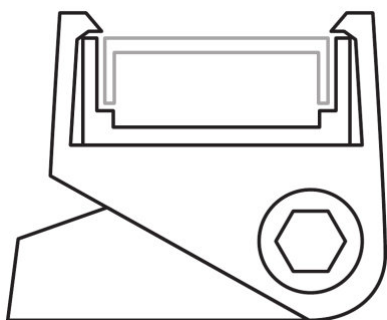
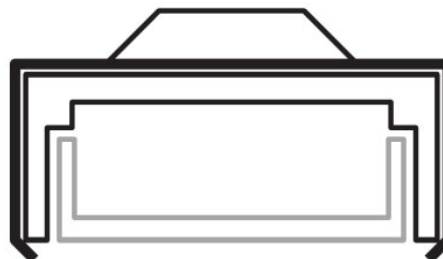
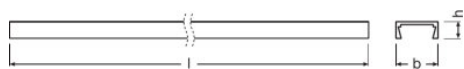

Product weight	245.00 g
Length	3000 mm
Width	15.2 mm
Height	6.0 mm

Logistical data





Commodity code	760429909000
-----------------------	--------------

Product datasheet

Environmental information

Information according Art. 33 of EU Regulation (EC) 1907/2006 (REACH)	
Date of Declaration	30-08-2022
Primary Article Identifier	4052899448865
Candidate List Substance 1	No declarable substances contained
Declaration No. in SCIP database	No declarable substances contained

Download Data

File
 Product Datasheet Specification Sheet Slim Track FX-QMS-G1-TU15H6-300 (EN)
 Brochures Light is freedom of design (EN)
 CAD data CAD file slim profile TU15H6
 Eulumdat Eulumdat_FX-QMS-G1-TU15H6-300_CFDL

Logistical Data

Product code	Product description	Packaging unit (Pieces/Unit)	Dimensions (length x width x height)	Volume	Gross weight
4052899448865	FX-QMS-G1 -TU15H6-300	Shipping carton box 40	3020 mm x 100 mm x 100 mm	30.20 dm ³	10880.00 g

The mentioned product code describes the smallest quantity unit which can be ordered. One shipping unit can contain one or more single products. When placing an order, for the quantity please enter single or multiples of a shipping unit.

Accessories Optional

Product description	Accessory name	Accessory code
FX-QMS-G1 -TU15H6-300	FX-QMS-G1 -CFDB-300	▶ 4052899446991
FX-QMS-G1 -TU15H6-300	FX-QMS-G1 -BMZI-DIV1	▶ 4052899446861
FX-QMS-G1 -TU15H6-300	FX-QMS-G1 -EFGP-TU15H6	▶ 4052899449107
FX-QMS-G1 -TU15H6-300	FX-QMS-G1 -CFTL-300	▶ 4052899999749
FX-QMS-G1 -TU15H6-300	FX-QMS-G1 -EFGH-TU15H6	▶ 4052899999923
FX-QMS-G1 -TU15H6-300	ADJUSTABLESLIMBRACKET	▶ 4052899600010

Product datasheet

Disclaimer

Subject to change without notice. Errors and omission excepted. Always make sure to use the most recent release.