

## FX-QMW-G1-TU26H25W2

### Accessories for Flexible LED strips



#### Product family features

- Can be easily combined with covers for homogeneous light distribution
- Clips for easy installation and maintenance
- Compatible with Linearlight Flex
- Ideal even for lighting in confined spaces
- Compatible with TEC Flex

#### Product family benefits

- Plenty of freedom for attractive design and perfect functioning
- Quick and easy installation
- Aluminum profile robust and corrosion-resistant thanks to anodization
- Minimum installation dimensions thanks to compact design

## Product family datasheet

### Technical data

Product description	Dimensions & weight				Logistical data
	Height	Width	Length	Product weight	Commodity code
FX-QMW-G1 -TU26H25W2-300	25.0 mm	30.0 mm	3000 mm	782.00 g	760429909000
FX-QMW-G1 -EFGP-TU26H25W2	12.0 mm	24.5 mm	30.0 mm	1.30 g	392690979000
FX-QMW-G1 -CFDB-300	4.0 mm	22.0 mm	3000 mm	96.00 g	391690509000
FX-QMW-G1 -CRD-300	20.0 mm	24.0 mm	3000 mm	282.00 g	391690509000
FX-QMW-G1 -CFTP-300	2.0 mm	22.0 mm	3000 mm	15.90 g	392690979000
FX-QMW-G1 -ERGP-DIV1	6.0 mm	13.0 mm	24.0 mm	1.00 g	392690979000

Product description	Environmental information Information according Art. 33 of EU Regulation (EC) 1907/2006 (REACH)			
	Date of Declaration	Primary Article Identifier	Candidate List Substance 1	Declaration No. in SCIP database
FX-QMW-G1 -TU26H25W2-300	30-08-2022	4052899448841	No declarable substances contained	No declarable substances contained
FX-QMW-G1 -EFGP-TU26H25W2	30-08-2022	4052899450219	No declarable substances contained	No declarable substances contained
FX-QMW-G1 -CFDB-300	30-08-2022	4052899447806	No declarable substances contained	No declarable substances contained
FX-QMW-G1 -CRD-300	30-08-2022	4052899447035	No declarable substances contained	No declarable substances contained
FX-QMW-G1 -CFTP-300	02-02-2022	4052899999787	No declarable substances contained	No declarable substances contained
FX-QMW-G1 -ERGP-DIV1	11-02-2022	4052899999824	No declarable substances contained	No declarable substances contained

## Product family datasheet

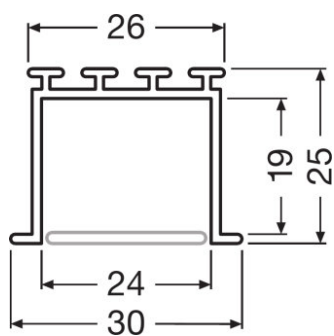

728415\_TU26H25W2

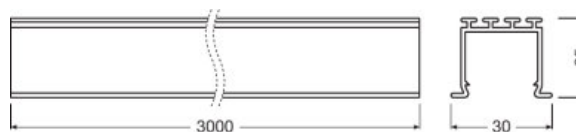

728994\_FX-QMW-G1-TU26H25W2-300

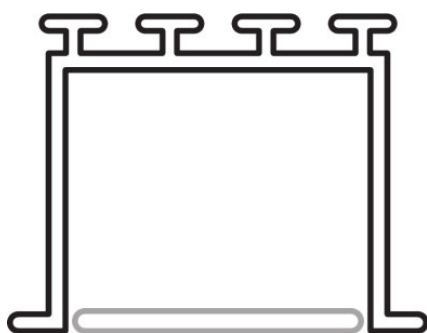

728447\_TU26H25W2

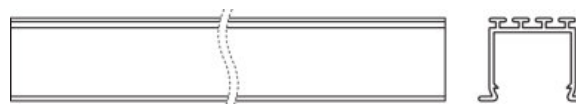

729061\_FX-QMW-G1-TU26H25W2-300

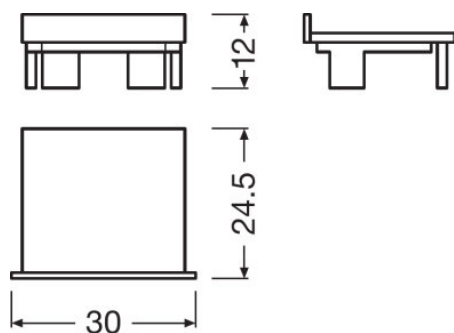

729111\_FX-QMW-G1-EFGP-TU26H25W2

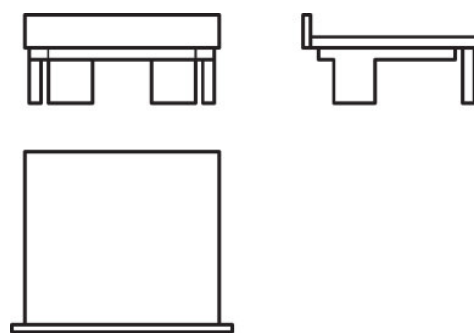

729088\_FX-QMW-G1-EFGP-TU26H25W2

# Product family datasheet



729112\_FX-QMW-G1-CFDB-300



729089\_FX-QMW-G1-CFDB-300

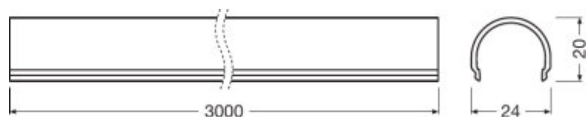

729000\_FX-QMW-G1-CRD-300



729067\_FX-QMW-G1-CRD-300

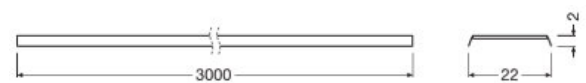

FX-QMW-G1-CFTP-300

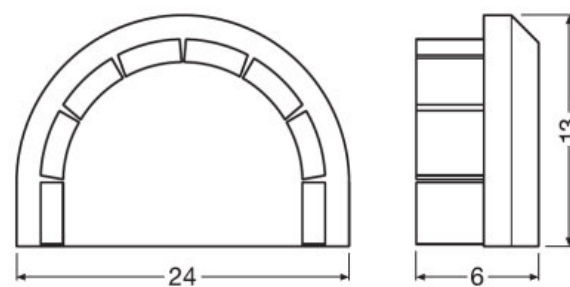

FX-QMW-G1-ERGP-DIV1

## Product family datasheet







### Application advice

For more detailed application information and graphics please see product datasheet.

### Sales and Technical Support

Sales and Technical Support [www.osram.com](http://www.osram.com)

### Download Data

File	
	Product Datasheet Specification Sheet Wide Track FX-QMW-G1-TU26H25W2-300 (EN)
	Brochures Light is freedom of design (EN)
	CAD data CAD file wide profile TU26H25W2
	Product Datasheet Specification Sheet_Wide Track FX-QMW-G1-TK30D46H27-300 (EN)
	Product Datasheet Specification Sheet Wide Track FX-QMW-G1-TU26H25-300 (EN)
	Product Datasheet Specification Sheet Wide Track FX-QMW-G1-TU26H25W10-300
	Product Datasheet Specification Sheet_Wide Track FX-QMW-G1-TU26H8-300 (EN)

### Logistical Data

Product code	Product description	Packaging unit (Pieces/Unit)	Dimensions (length x width x height)	Volume	Gross weight
4052899448841	FX-QMW-G1 - TU26H25W2-300	Shipping carton box 20	3020 mm x 100 mm x 100 mm	30.20 dm <sup>3</sup>	16800.00 g
4052899450219	FX-QMW-G1 -EFGP- TU26H25W2	Shipping carton box 400	250 mm x 245 mm x 180 mm	11.03 dm <sup>3</sup>	840.00 g
4052899447806	FX-QMW-G1 -CFDB-300	Shipping carton box 40	3020 mm x 80 mm x 30 mm	7.25 dm <sup>3</sup>	4380.00 g
4052899447035	FX-QMW-G1 -CRD-300	Shipping carton box 40	3020 mm x 200 mm x 200 mm	120.80 dm <sup>3</sup>	13300.00 g
4052899999787	FX-QMW-G1 -CFTP-300	Shipping carton box 40	3020 mm x 80 mm x 30 mm	7.25 dm <sup>3</sup>	1176.00 g
4052899999824	FX-QMW-G1 -ERGP-DIV1	Shipping carton box 400	175 mm x 145 mm x 110 mm	2.79 dm <sup>3</sup>	506.00 g

## Product family datasheet

---

### Logistical Data

The mentioned product code describes the smallest quantity unit which can be ordered. One shipping unit can contain one or more single products. When placing an order, for the quantity please enter single or multiples of a shipping unit.

---

### Accessories Optional

Product description	Accessory name	Accessory code
FX-QMW-G1 -TU26H25W2-300	FX-QMW-G1 -SRME-DIV1	▶ 4052899446786
FX-QMW-G1 -TU26H25W2-300	FX-QMW-G1 -CFDB-300	▶ 4052899447806
FX-QMW-G1 -TU26H25W2-300	FX-QMW-G1 -CRD-300	▶ 4052899447035
FX-QMW-G1 -TU26H25W2-300	FX-QMW-G1 -EFGP-TU26H25W2	▶ 4052899450219
FX-QMW-G1 -TU26H25W2-300	FX-QMW-G1 -CFTP-300	▶ 4052899999787
FX-QMW-G1 -TU26H25W2-300	FX-QMW-G1 -ERGP-DIV1	▶ 4052899999824

---

### Disclaimer

Subject to change without notice. Errors and omission excepted. Always make sure to use the most recent release.