

LIGHTsignal LED BEACON LIGHT

Warning and safety lights



360° LED rotating beacon light

Improved visibility and therefore increased safety for you and others



12V & 24V compatible

Different application possibilities and high flexibility since compatible with both 12V and 24V vehicles



Protection class: IP65 & IK08

The OSRAM LIGHTsignal LED has been tested in our DIN EN ISO/IEC 17025 certified environmental simulation laboratory for extreme external influences in terms of water, dust, heat, cold and impacts and validated with the protection classes IP65 & IK 08



ECE Certified - ECE R65 & ECE R10

The required tests and approvals have been carried out and an ECE type approval has been granted¹⁾

Light is safety- See and be seen with OSRAM

The OSRAM LIGHTsignal LED BEACON LIGHT is a 360° rotating, amber LED rotating beacon that can be mounted on vehicles with unusual width, length or load, as well as on municipal vehicles, emergency vehicles, command vehicles and accident assistance vehicles to draw attention to an unusual situation in road traffic or in the working environment. The rotating beacon from OSRAM can be used for better visual recognition, marking and securing of danger spots or special locations. Furthermore, rotating

Product datasheet



beacons are used in certain facilities, on machines and devices as well as in alarm systems. The LED rotating beacon from OSRAM is characterized by a high efficiency due to eight long-life high-power LEDs with up to 1900 Kelvin and 1200 Lumen, thus ensuring improved visibility and thus increased safety for you and others - during the day and at night. Thanks to the non-slip, shock-absorbing rubber base, the LED warning light from OSRAM has a particularly high vibration insensitivity. At the same time, the fully rubberized base contributes as a seal between the product and the underground. In addition, the robust, shatterproof housing made of polycarbonate withstands even heavier loads. To reduce and prevent dirt from accumulating on the beacon, the OSRAM LIGHTsignal LED uses a smooth surface on the housing, thus preventing the signal effect from being impaired by dirt. The OSRAM LIGHTsignal LED BEACON LIGHT convinces with a high luminosity and at the same time with a low power consumption. Thanks to the low power consumption of the LEDs, the rotating warning light from OSRAM is also suitable for use over a longer period. Due to the compact and modern design, the beacon offers different application possibilities and a high flexibility since this is compatible with both 12V and 24V vehicles. The mounting material included in the delivery allows a direct and accurate mounting and thus an immediate use of the beacons. The three-point mounting system allows the beacon to be securely and firmly mounted on the vehicle roof. In addition, the LIGHTsignal LED warning light from OSRAM complies with the ECE R10 and R65 guidelines and is therefore approved for use in road traffic¹⁾ The OSRAM LIGHTsignal LED has been tested in our DIN EN ISO/IEC 17025 certified environmental simulation laboratory for extreme external influences in terms of water, dust, heat, cold and impacts from falls and validated with protection classes IP65 & IK08. The integrated thermal management system regulates the temperature of the LED light and can prevent damage from overheating. The polarity protection inhibits incorrect polarity reversal in the power supply and can thus avert possible damage, due to the automatic shutdown of the LEDs. OSRAM provides a 2-year guarantee²⁾ on this

product.

Special regulations apply regarding the use and application of rotating beacons. This is regulated in the respective, country-specific road traffic licensing regulations.

Product datasheet

Technical data

Product information

| | |
|---|---|
| Product legal advice 1 | 1) Special regulations apply regarding the use and application of rotating beacons. This is regulated in the respective, country-specific road traffic licensing regulations. |
| Product legal advice 2 | 2) For precise conditions please refer to: www.osram.com/am-guarantee |
| Application (Category and Product specific) | Warning and safety lights |

General Product Information

| | |
|------------------------|--------|
| Global order reference | RBL102 |
|------------------------|--------|

Electrical Data

| | |
|-----------------|---------|
| Nominal wattage | 7 W |
| Nominal voltage | 12/24 V |

Photometric Data

| | |
|-------------------|--------|
| Color temperature | 1900 K |
| Light color LED | Amber |

Physical Attributes & Dimensions

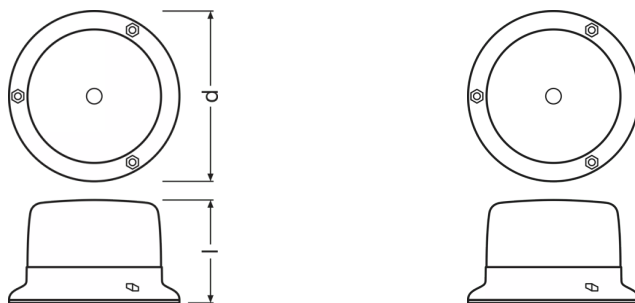

| | |
|----------------|----------|
| Product weight | 305.00 g |
| Length | 148.0 mm |
| Height | 89.0 mm |

Lifetime Data

| | |
|-----------|---------|
| Guarantee | 2 years |
|-----------|---------|

Product datasheet

Capabilities

| | |
|------------|-----|
| Technology | LED |
|------------|-----|

Certificates & standards

| | |
|--------------------|-----------|
| Type of protection | IP65 IK08 |
|--------------------|-----------|

Environmental & Regulatory Information







| Information according Art. 33 of EU Regulation (EC) 1907/2006 (REACH) | |
|---|--|
| Candidate list substance 1 | Lead |
| CAS No. of substance 1 | 7439-92-1 |
| Safe use instruction | The identification of the Candidate List substance is sufficient to allow safe use of the article. |
| Declaration no. in SCIP database | e1a1078a-75eb-467d-8a4a-5afa301e21d0 |

Logistical Data

| Product code | Product description | Packaging unit (Pieces/Unit) | Dimensions (length x width x height) | Volume | Gross weight |
|---------------|------------------------------|------------------------------|--------------------------------------|-----------------------|--------------|
| 4062172232258 | LIGHTsignal LED BEACON LIGHT | Folding carton box 1 | 154 mm x 154 mm x 130 mm | 3.10 dm ³ | 372.00 g |
| 4062172232265 | LIGHTsignal LED BEACON LIGHT | Shipping carton box 12 | 470 mm x 315 mm x 315 mm | 46.64 dm ³ | 4804.00 g |

The mentioned product code describes the smallest quantity unit which can be ordered. One shipping unit can contain one or more single products. When placing an order, for the quantity please enter single or multiples of a shipping unit.

Download Data

| File | |
|---|--|
|  | User instruction LIGHTsignal LED |
|  | User instruction GPRS_Safety symbols instructions |
|  | Brochures OSRAM LIGHTsignal LED BEACON LIGHT flyer (EN) |
|  | Brochures OSRAM LIGHTsignal HAL BEACON LIGHT flyer (EN) |
|  | Movie application LIGHTsignal LED (EN) |
|  | Video OSRAM LIGHTsignal LED Beacon Light (EN) |

Product datasheet

Legal advice

¹⁾ The OSRAM LIGHTsignal LED BEACON LIGHT is approved according to ECE regulations and may therefore be installed and operated on public roads. In addition to the ECE approval of the product, individual special regulations and laws of the countries must be observed. Please note: Special regulations apply regarding the use and application of rotating beacons. This is regulated in the respective, country-specific road traffic licensing regulations.²⁾ For precise conditions please refer to: www.osram.com/am-guarantee Application advice: For more detailed application information and graphics please see product datasheet and user manual.

Application advice

For more detailed application information and graphics please see product datasheet.

Disclaimer

Subject to change without notice. Errors and omission excepted. Always make sure to use the most recent release.

The OSRAM logo is displayed in a bold, orange, sans-serif font.